

Grażyna Hase —

Zawsze
w modzie

Ubierz

warszawiankę

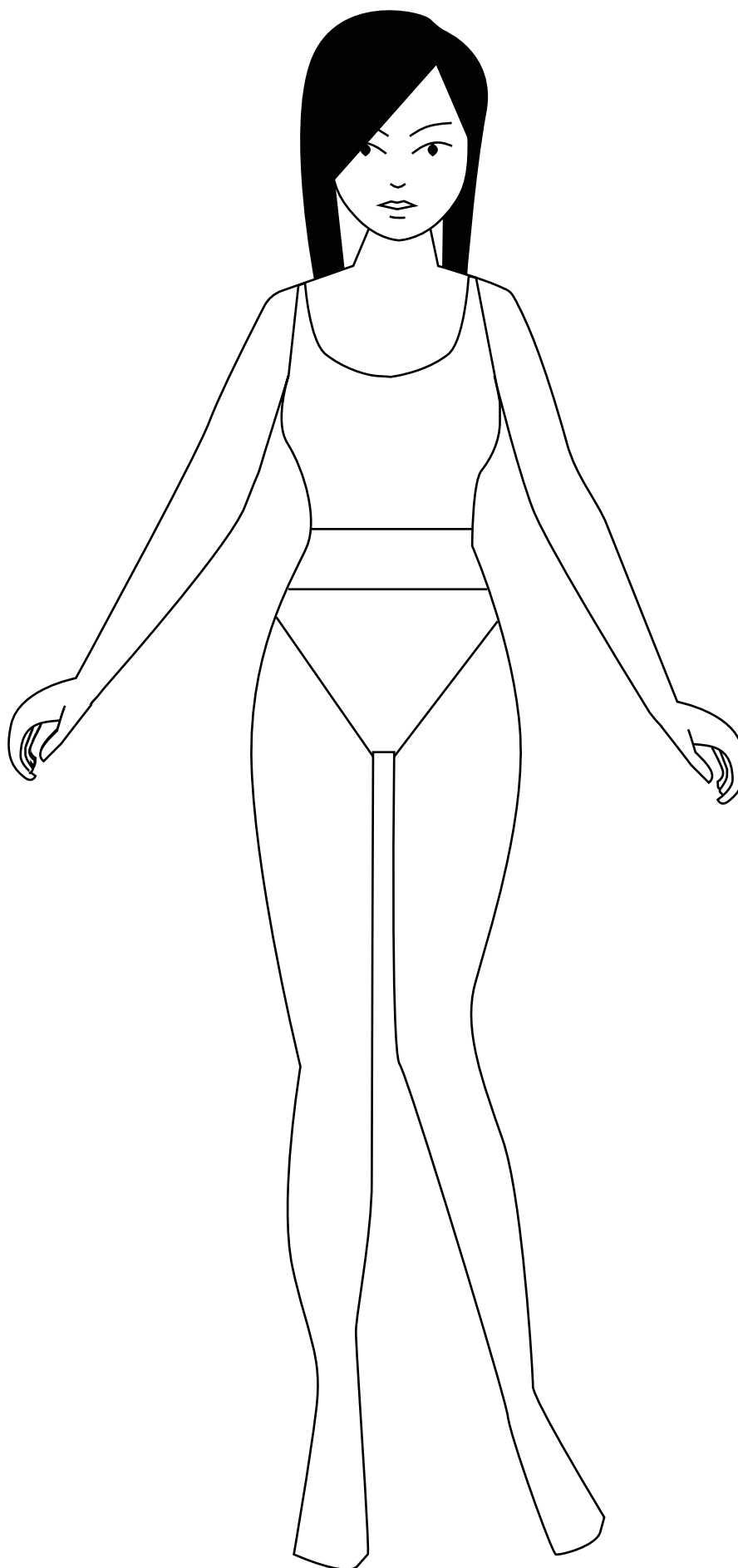

Ubierz warszawiankę

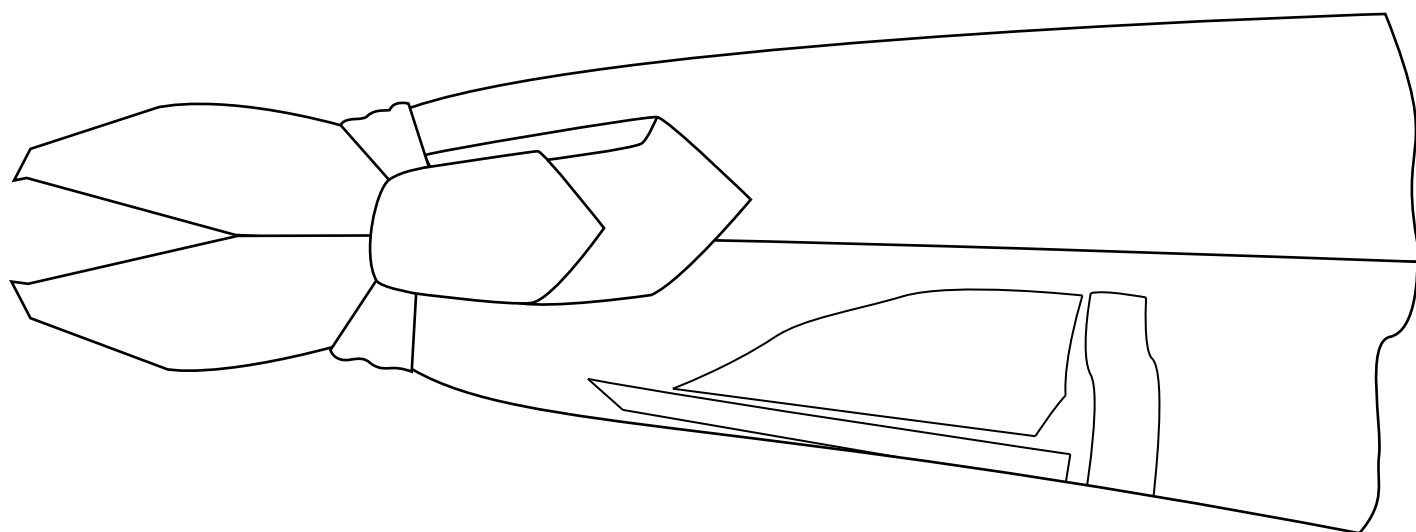
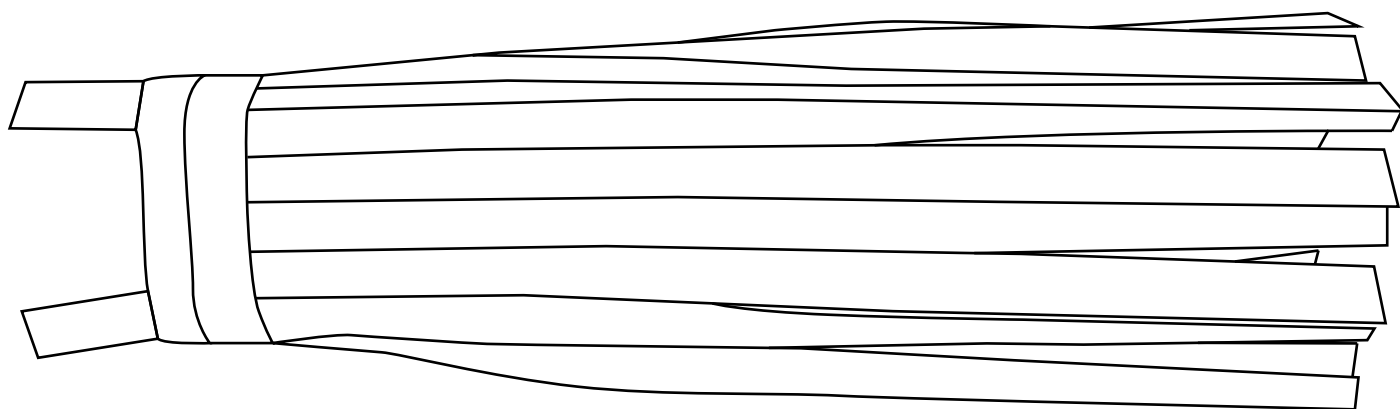
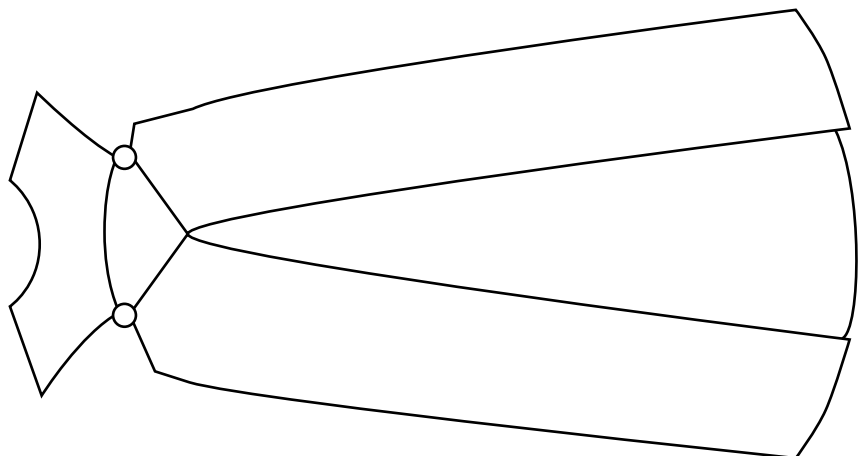
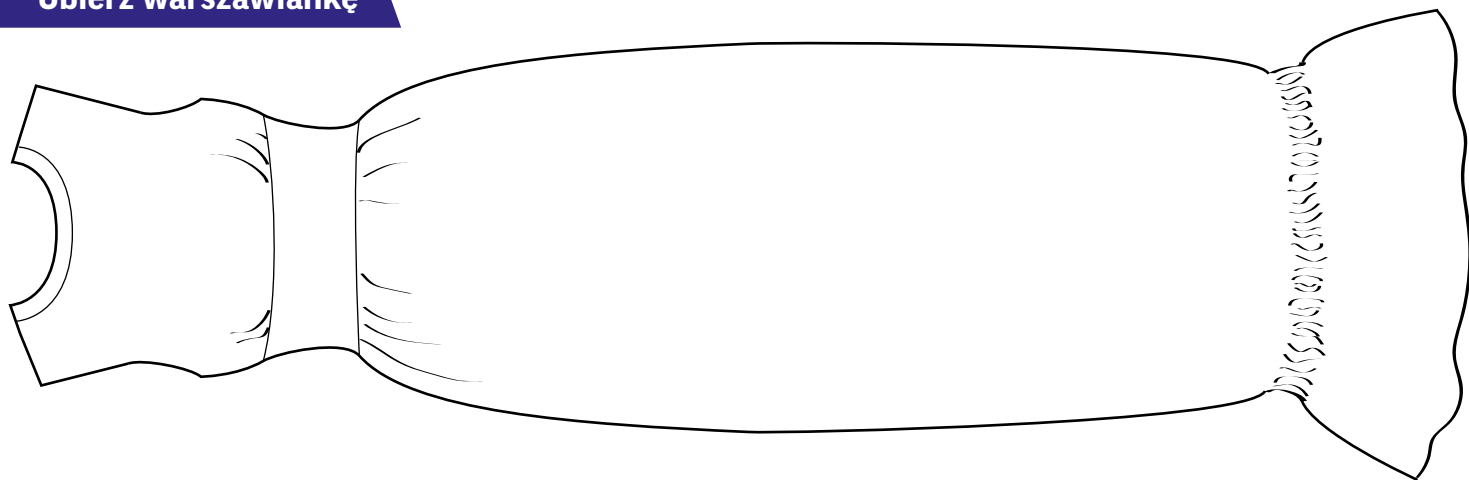

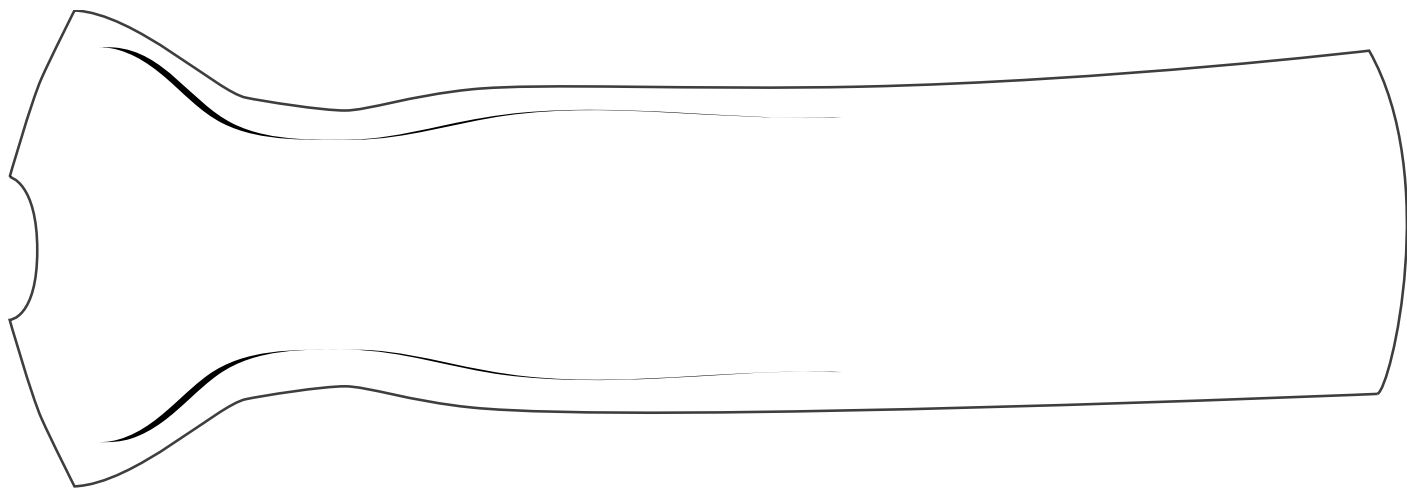
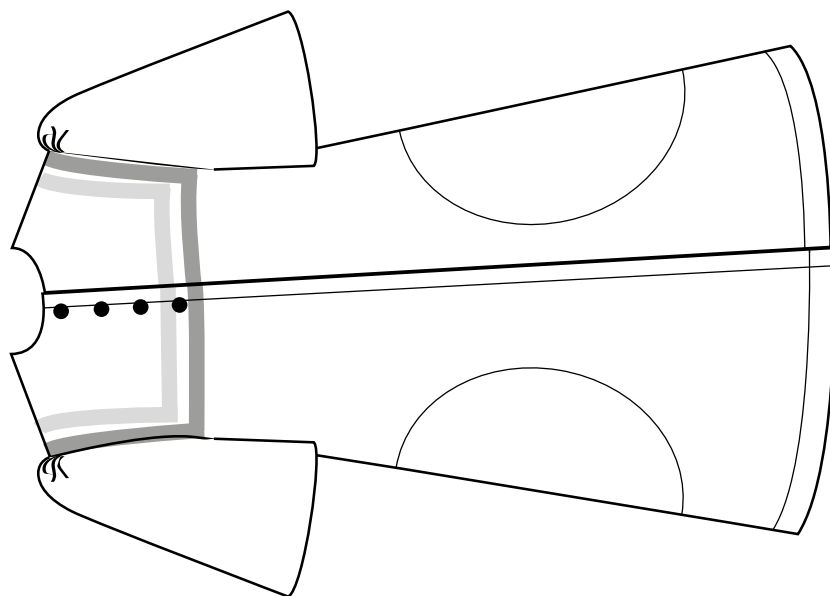
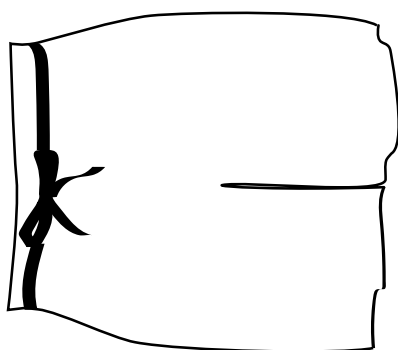
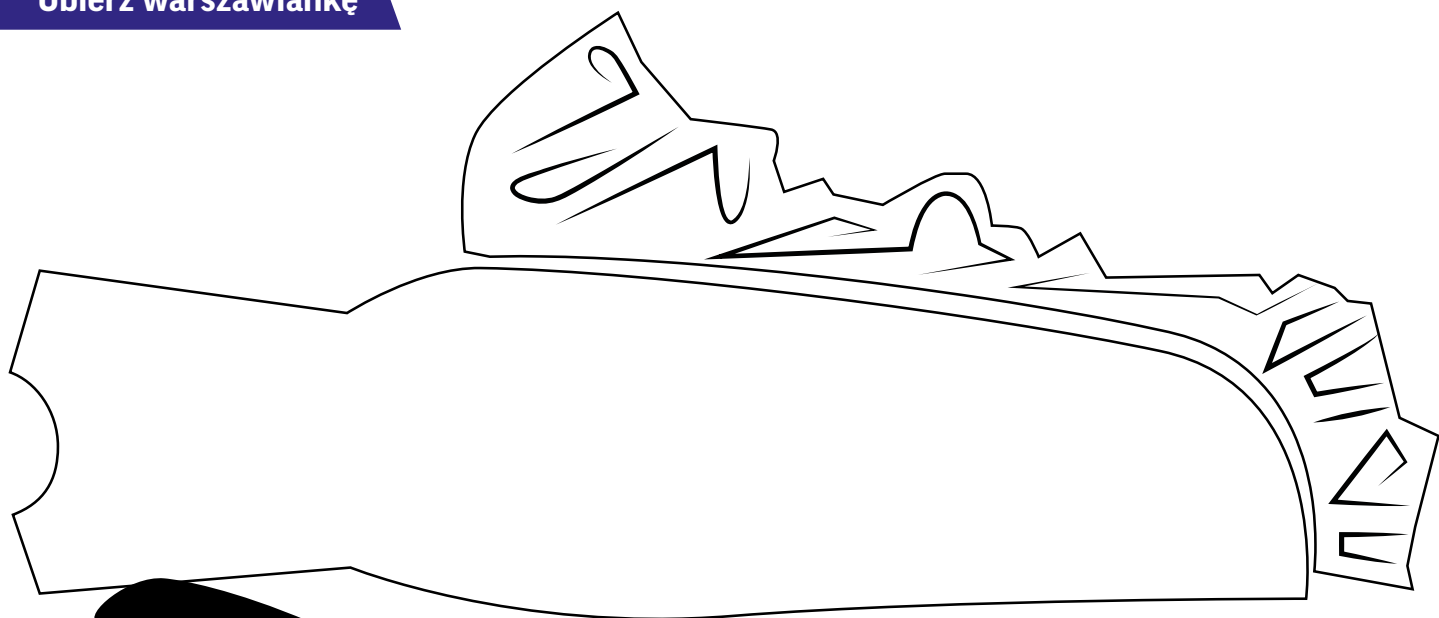

Ubierz warszawiankę

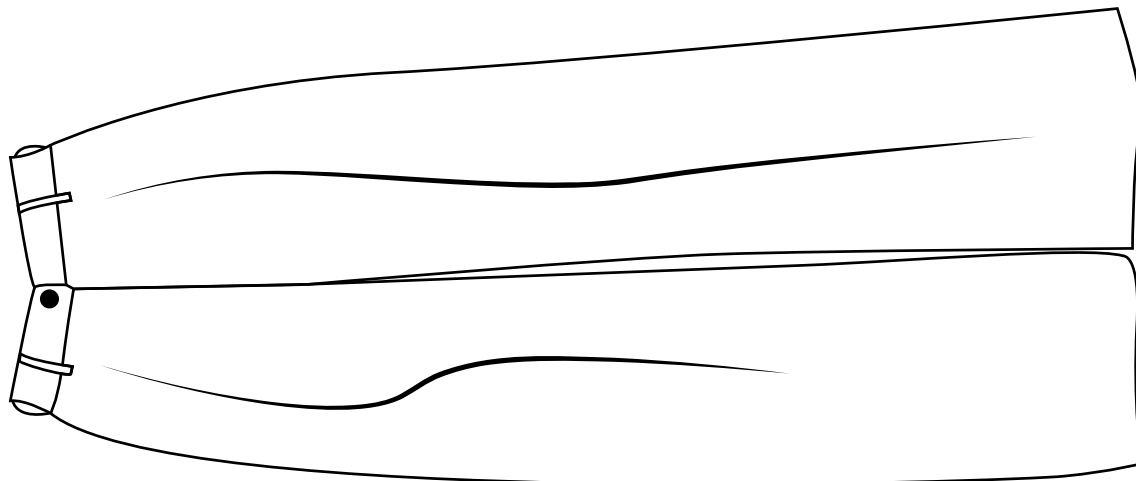
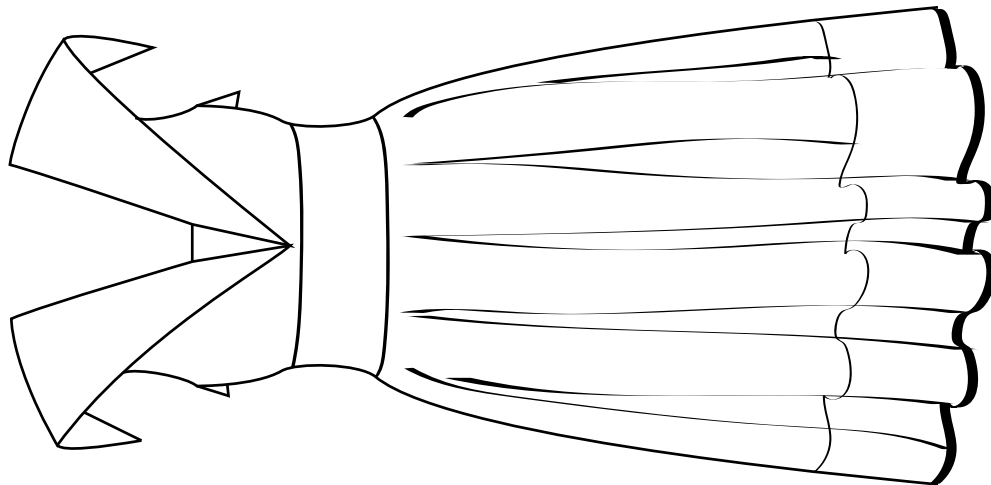
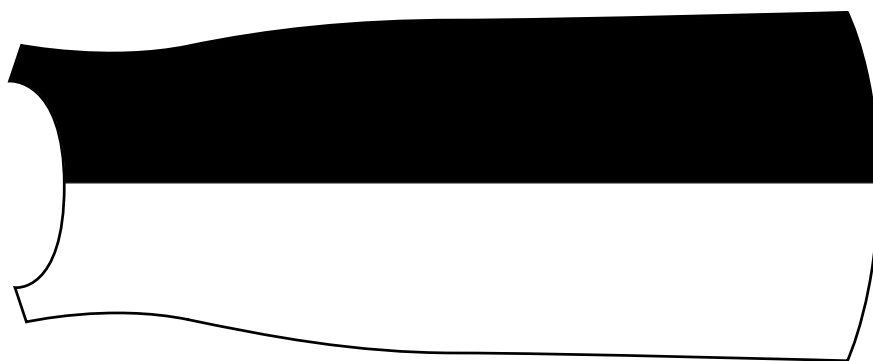
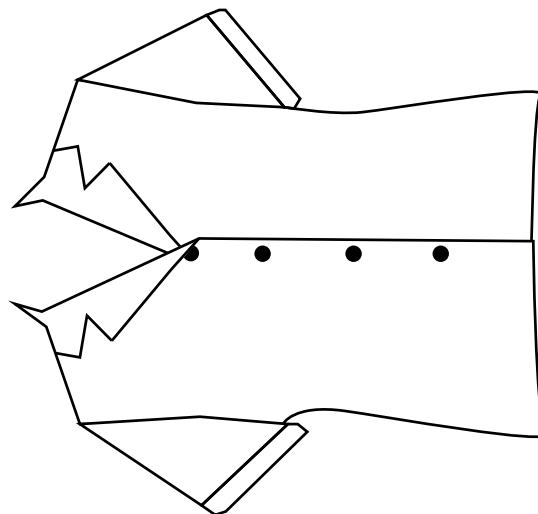
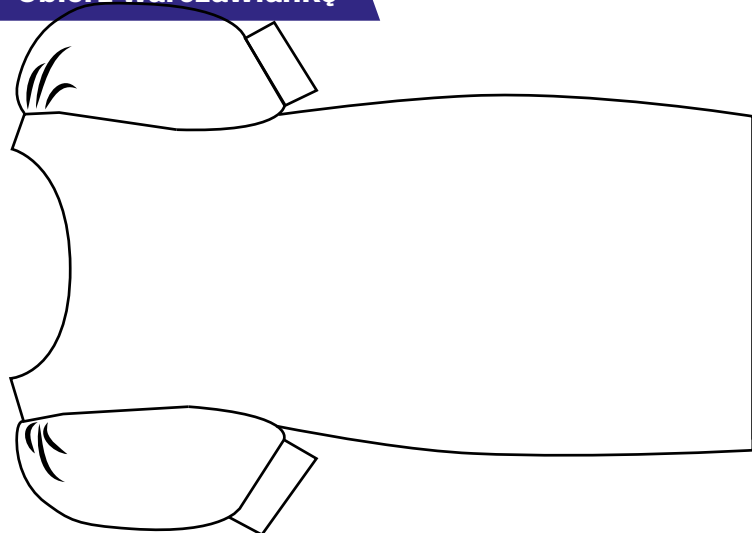

Ubierz warszawiankę

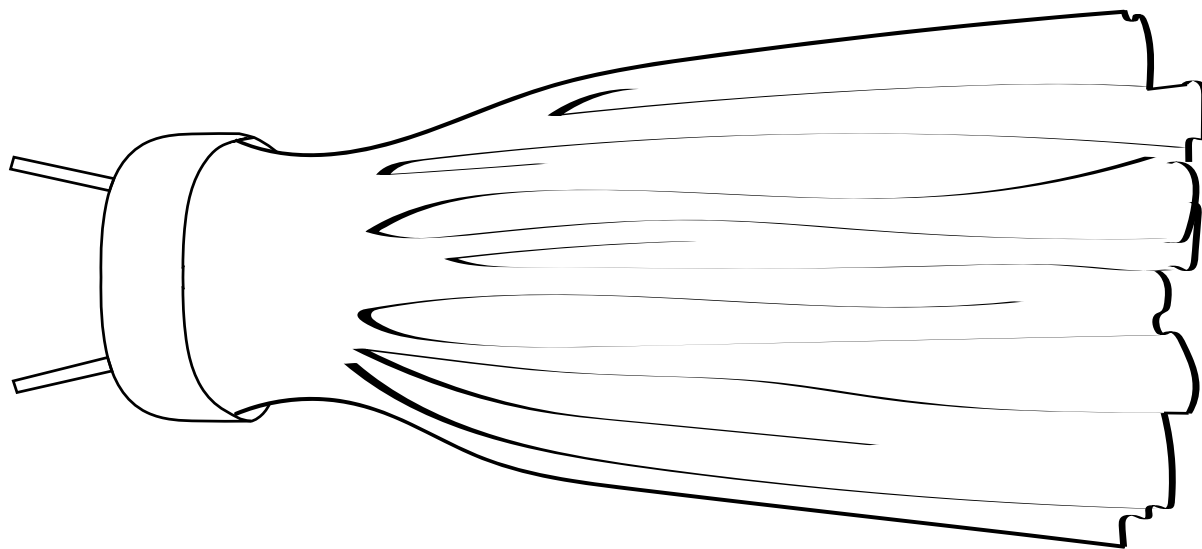
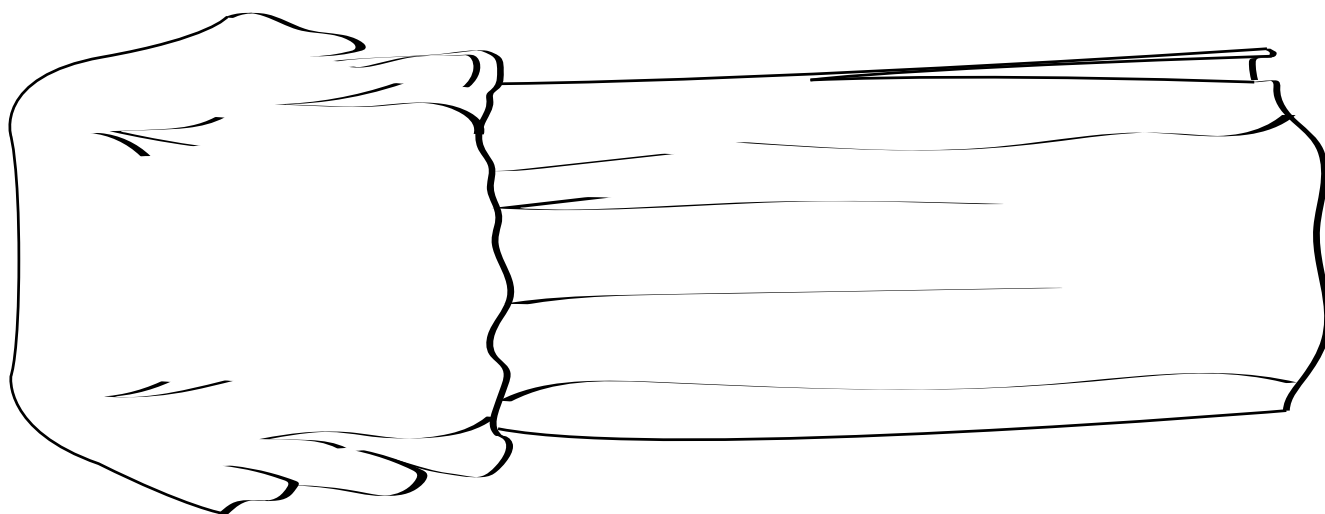
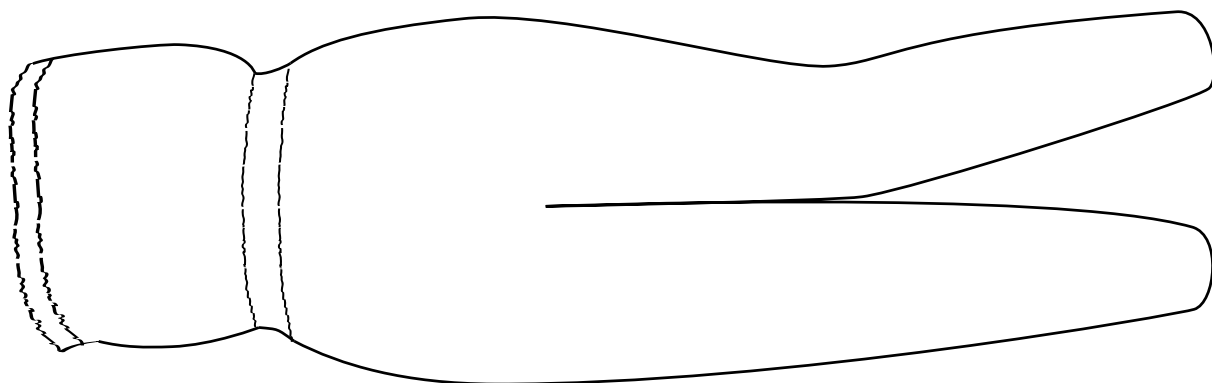
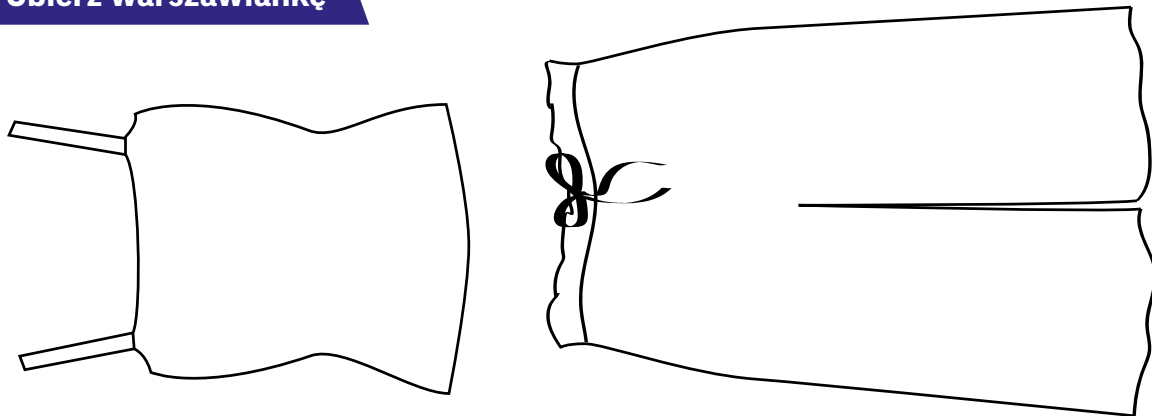

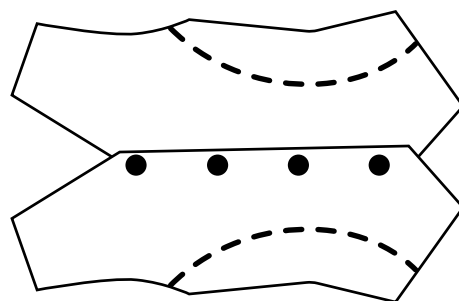
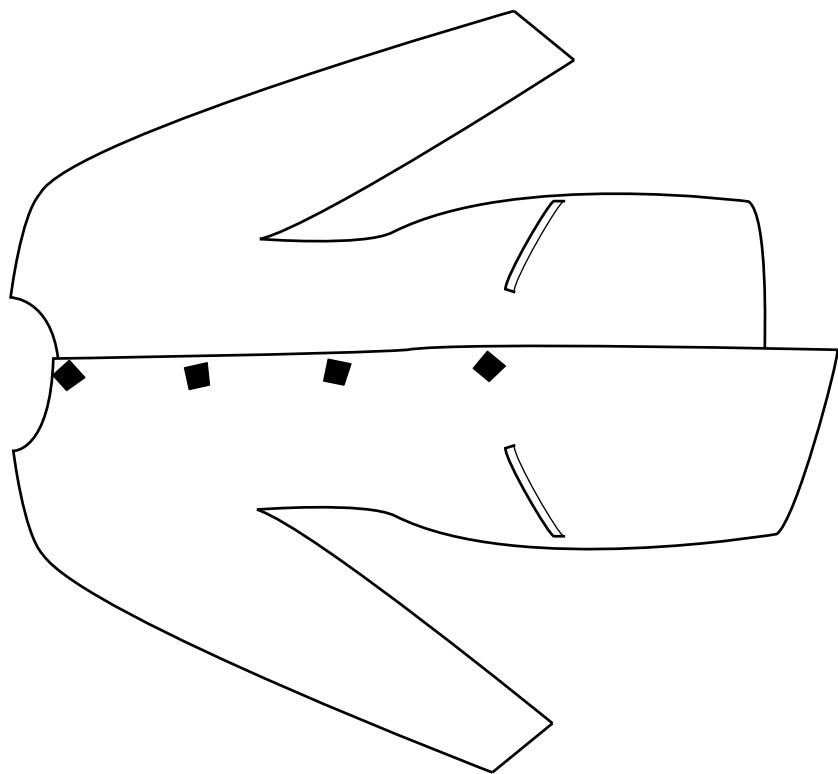
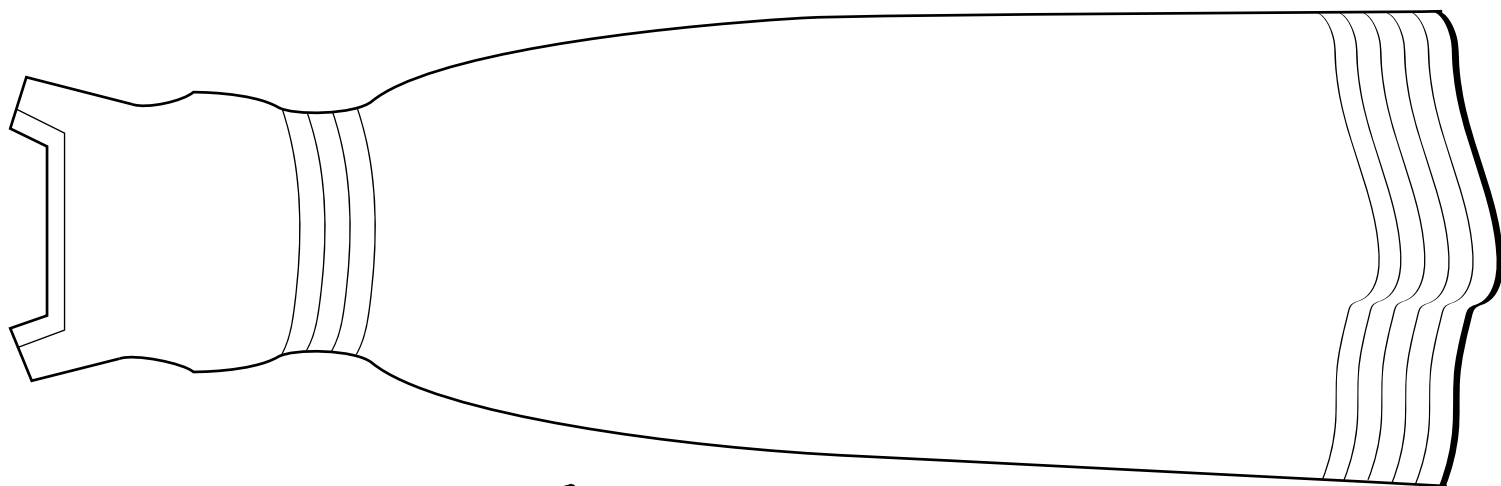
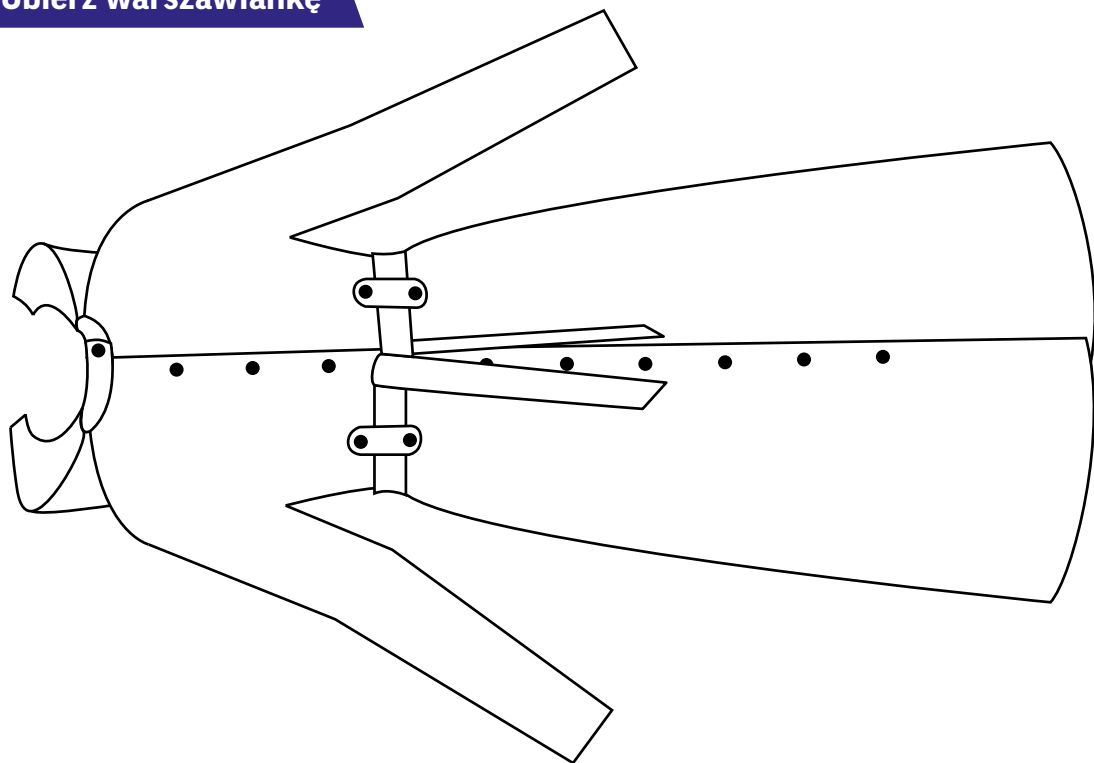

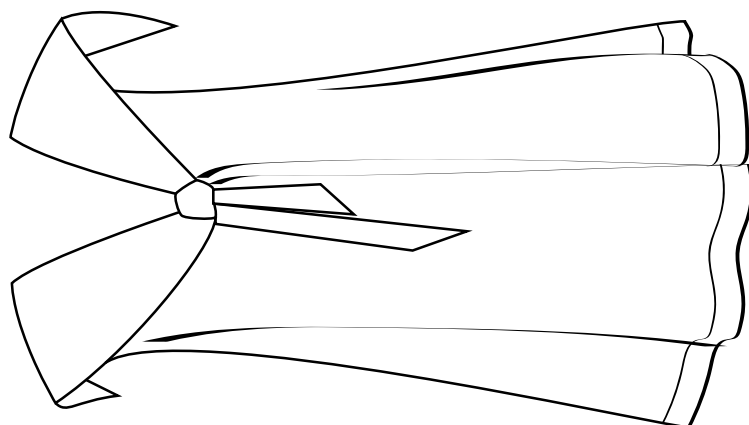
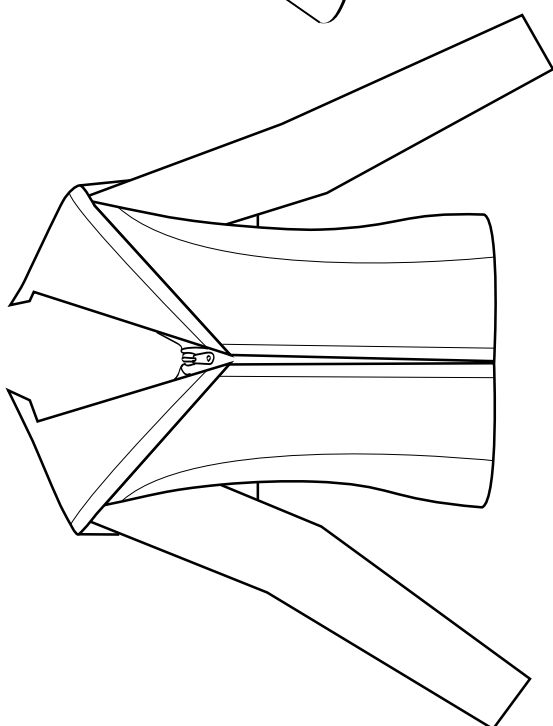
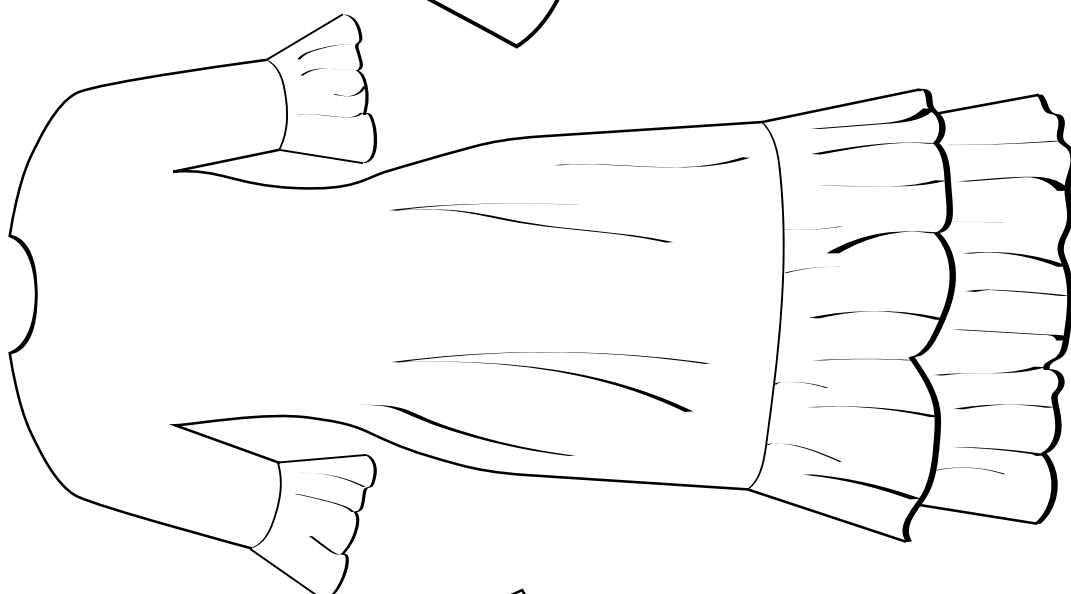
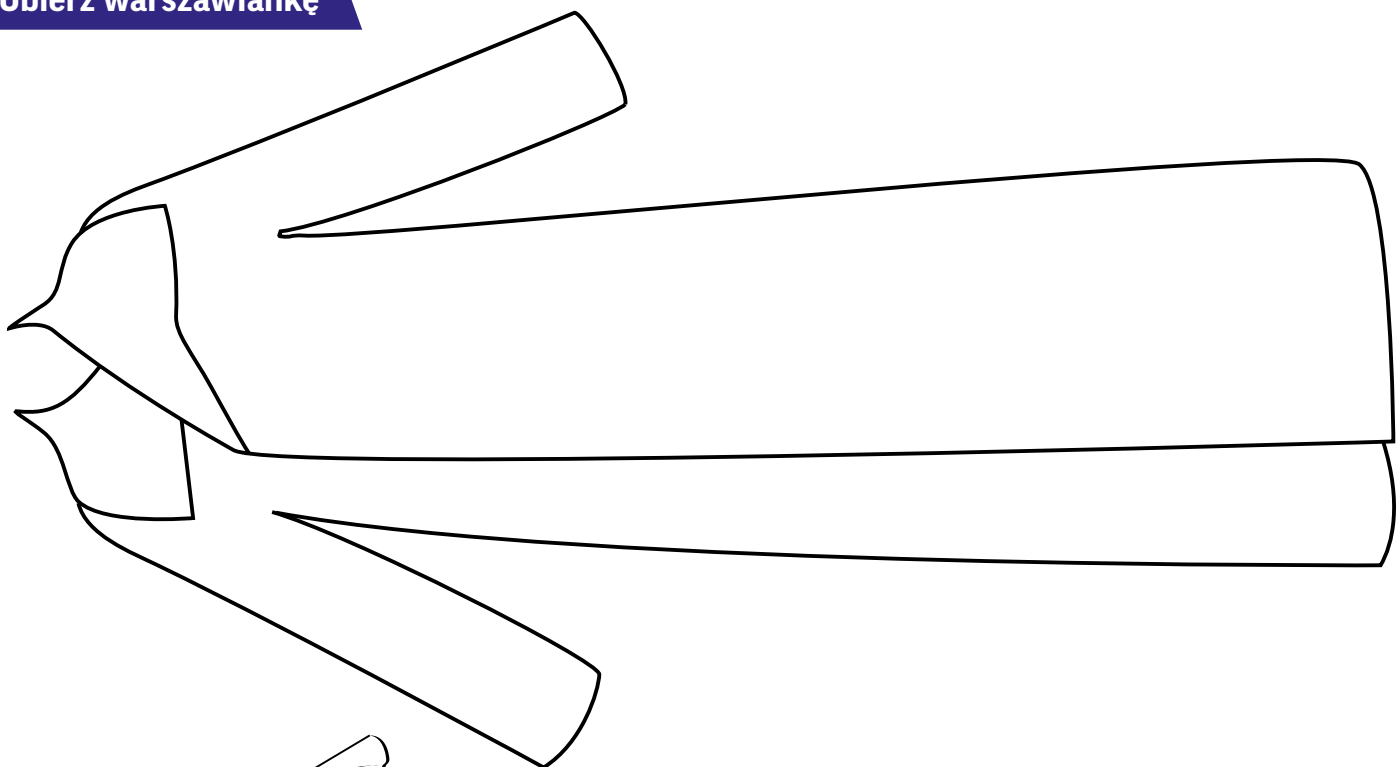

Ubierz warszawiankę

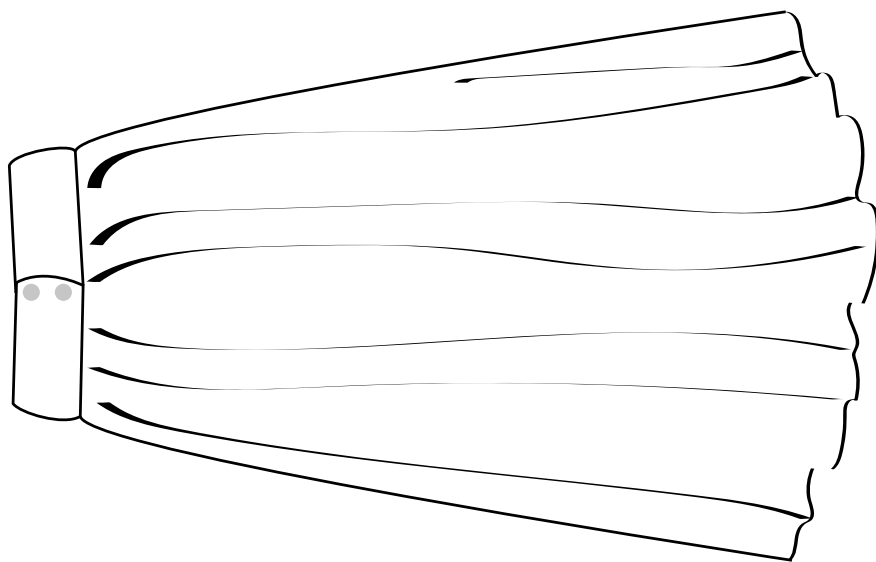
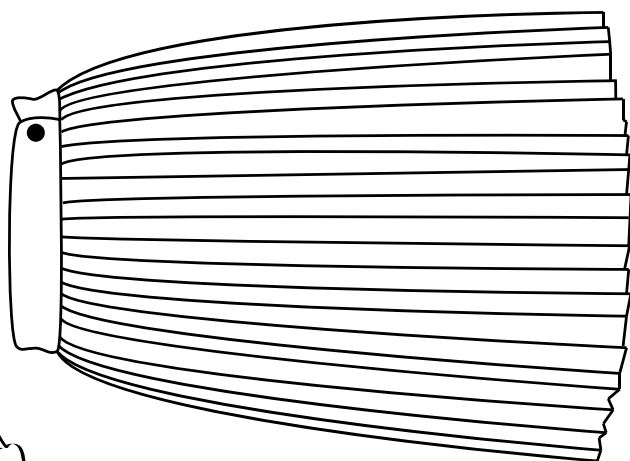
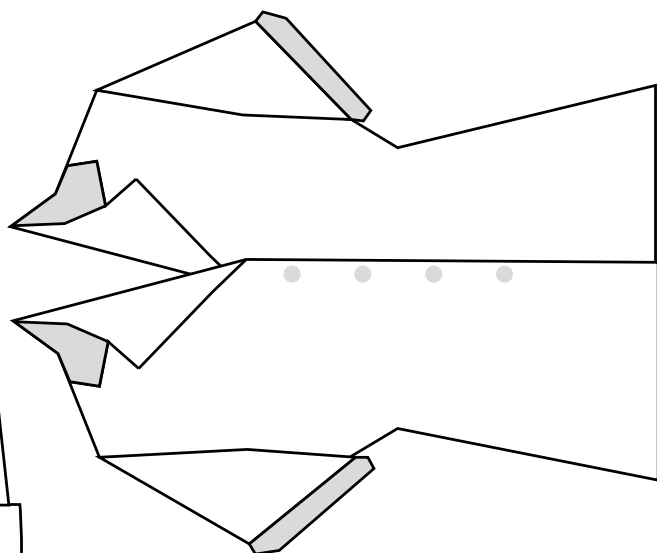
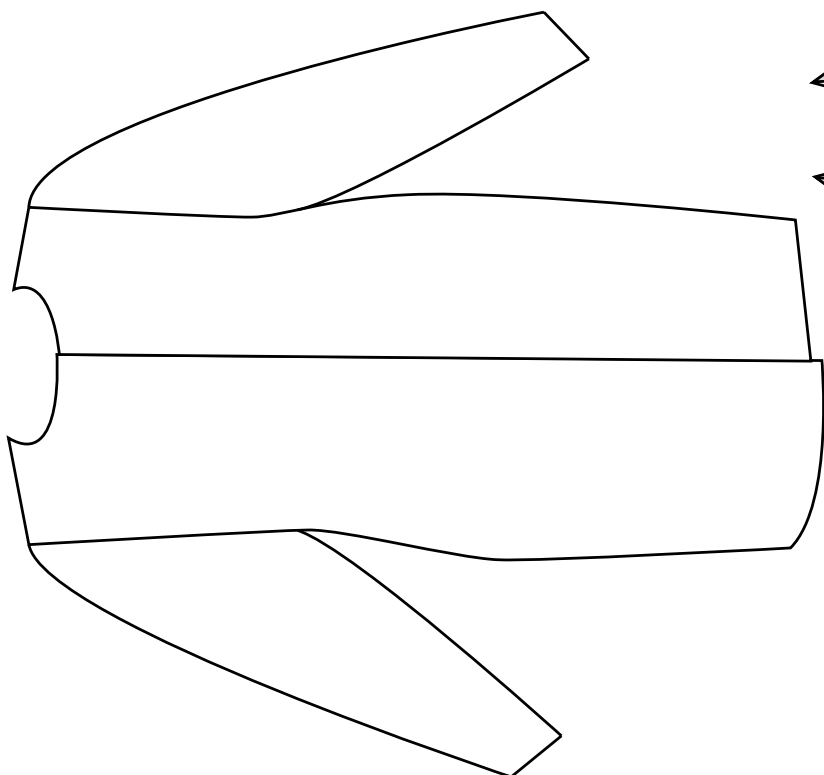
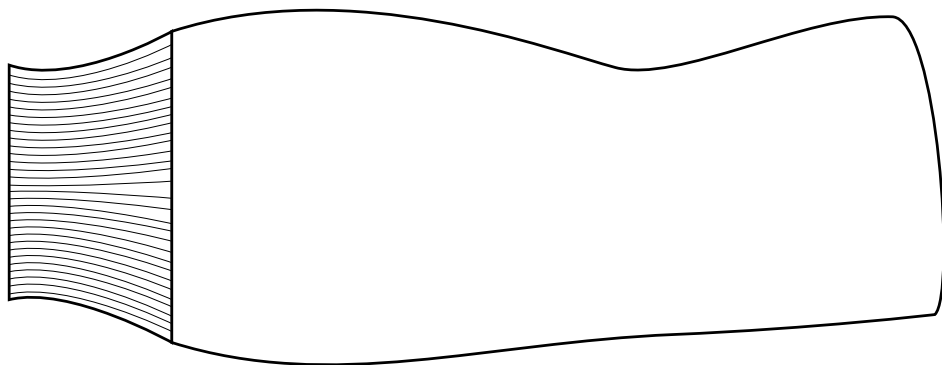
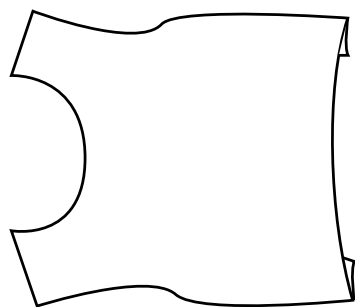

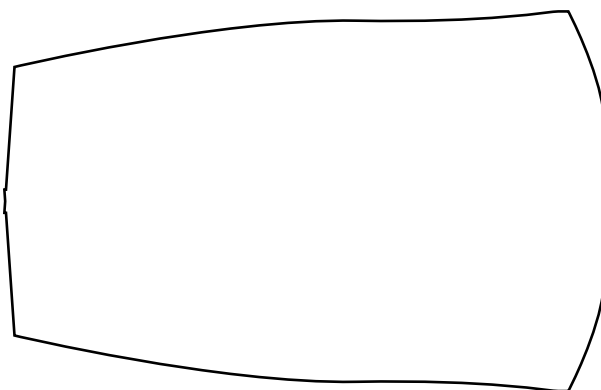
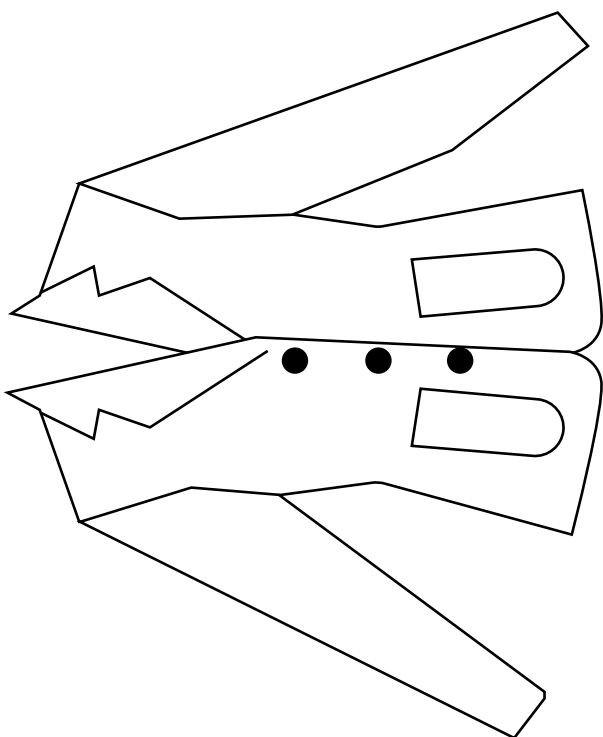
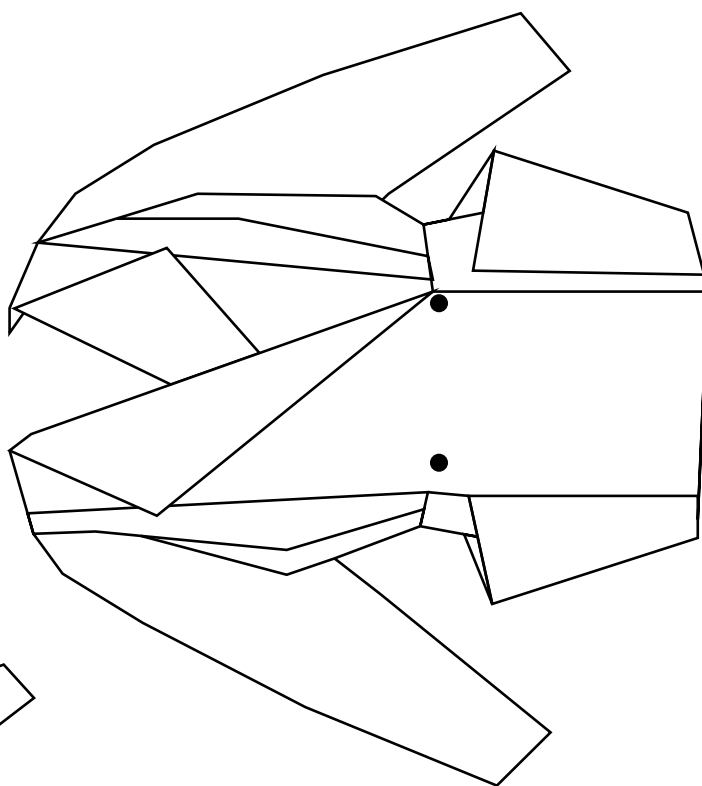
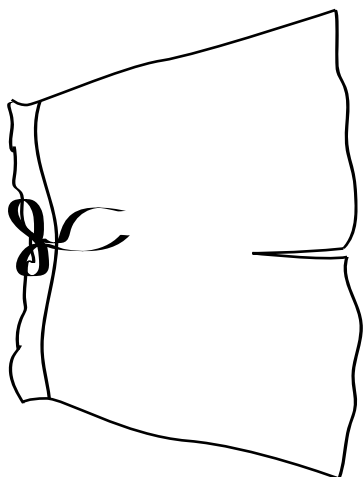
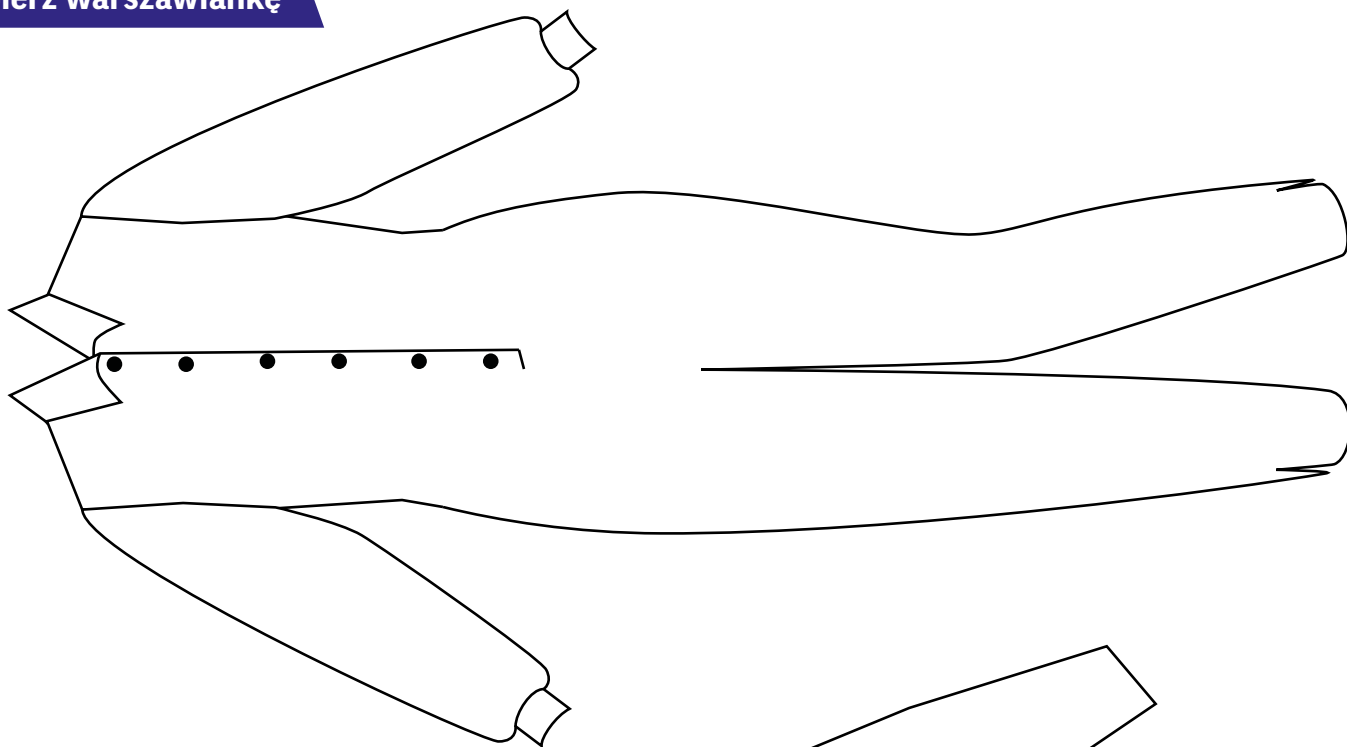

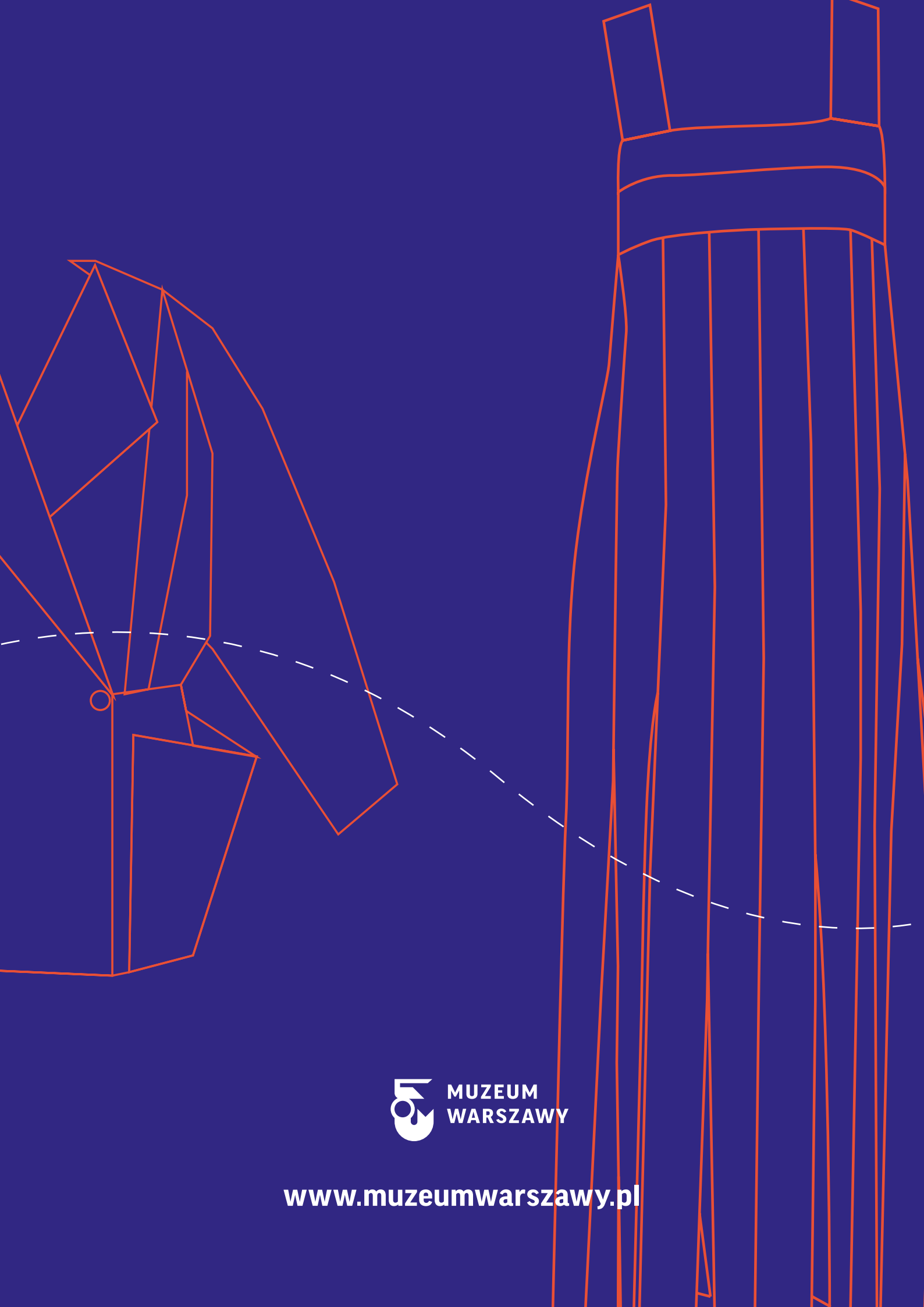

MUZEUM
WARSZAWY

www.muzeumwarszawy.pl